

92x38mm

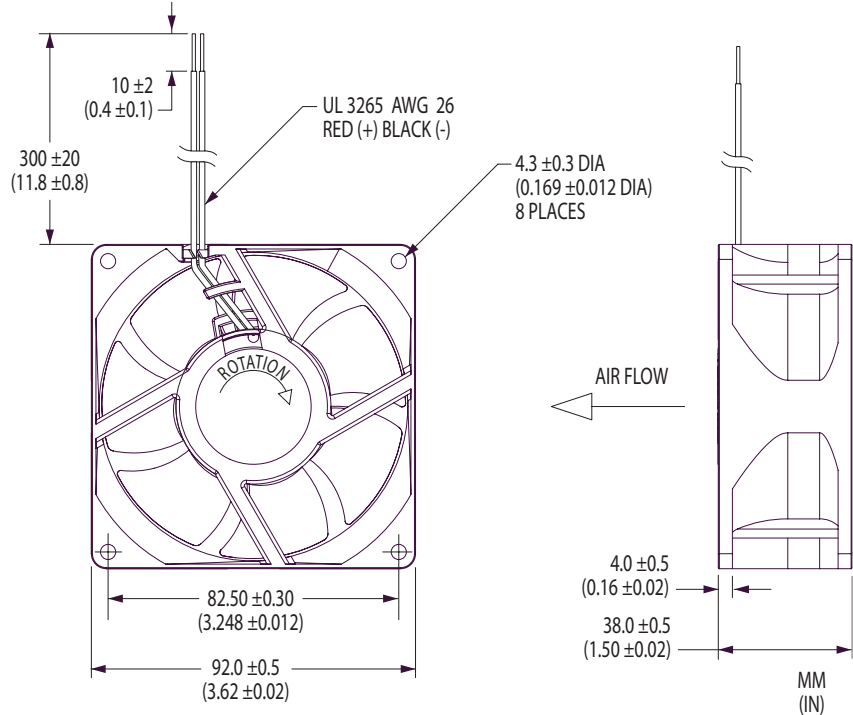

T92E Series

- ✓ Free-Running and Feedback-Governed, Speed-Stable Models
- ✓ Wide Variety of Monitor and Control Options and Signal Combinations
- ✓ Permanently Lubricated Dual Ball Bearings



Tube Axial Cooling Fans

Model	Air Flow (CFM)	Max. Static Pressure (inwg)	Operating Voltage		Operating Current (A)	Input Power (W)	Fan Speed (rpm)	Sound Pressure (dBA)	Operating Temp.		L10 Life† (hours)
			Nominal (V)	Range (V)					Min. (°C)	Max. (°C)	
Speed-Stable											
T92E12BUA7-01	150	1.44	12	7.0-13.8	2.09	25.1	7200	59.3	-10	+70	70,000
T92E12BGA7-01	130	1.09	12	7.0-13.8	1.34	16.1	6300	57.0	-10	+70	—
T92E12BHA7-01	99	0.68	12	7.0-13.8	0.61	7.3	4800	47.5	-10	+70	—
T92E12BMA7-01	83	0.50	12	7.0-13.8	0.39	4.7	4000	43.5	-10	+70	—
Free-Running											
T92E12BUA7-51	150	1.16	12	7.0-13.8	2.09	25.1	7200	59.3	-10	+70	70,000
T92E12BGA7-51	130	1.01	12	7.0-13.8	1.34	16.1	6300	57.0	-10	+70	—
T92E12BHA7-51	99	0.58	12	7.0-13.8	0.61	7.3	4800	47.5	-10	+70	—
T92E12BMA7-51	83	0.44	12	7.0-13.8	0.39	4.7	4000	43.5	-10	+70	—

Air flow, current, speed and sound pressure ratings are at nominal operating voltage and zero static pressure. Current and power ratings are average expected values under those conditions. † L10 bearing life expectancy at $T_A = +40^\circ\text{C}$. © UltraFlo is a registered trademark of Nidec Corporation.

Noise Power Emission Levels*

Operating Voltage (V)	Fraction of Max. Air Flow	Fan Speed (rpm)	Static Pressure (inwg)	NPEL (Bels)
Speed-Stable T92E12BUA7				
13.8	100%	7200	0	7.5
	80%	7195	0.43	7.2
	20%	7190	1.13	8.0
12.0	100%	7200	0	7.5
	80%	7195	0.43	7.2
	20%	7190	1.13	8.0
7.0	100%	5310	0	6.5
	80%	5255	0.22	6.2
	20%	5100	0.58	7.2
Free-Running T92E12BUA7				
13.8	100%	7880	0	7.6
	80%	7610	0.40	7.3
	20%	7300	1.12	8.1
12.0	100%	7200	0	7.5
	80%	7000	0.34	7.2
	20%	6730	0.93	7.8
7.0	100%	4500	0	5.9
	80%	4425	0.13	5.7
	20%	4315	0.38	6.7

* Sound levels in the tables are mean values, measured as the fans - without guards or other accessories - expel air from a test plenum on which they are mounted, using test methods and conventions prescribed by IPC-9591.



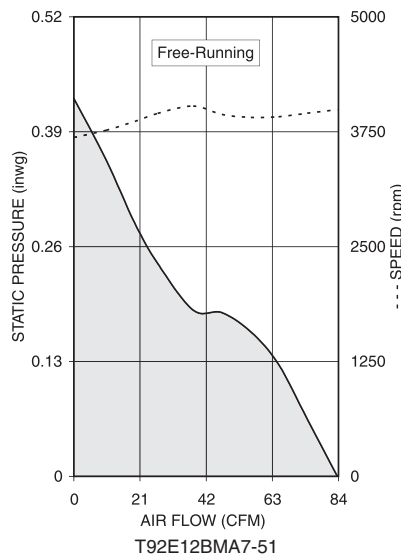
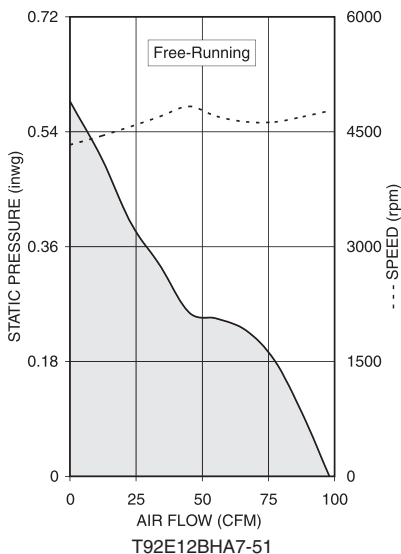
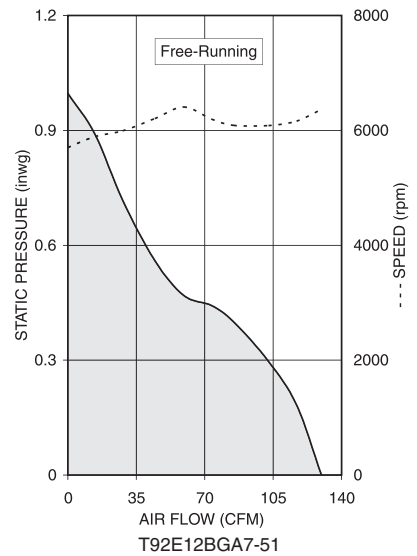
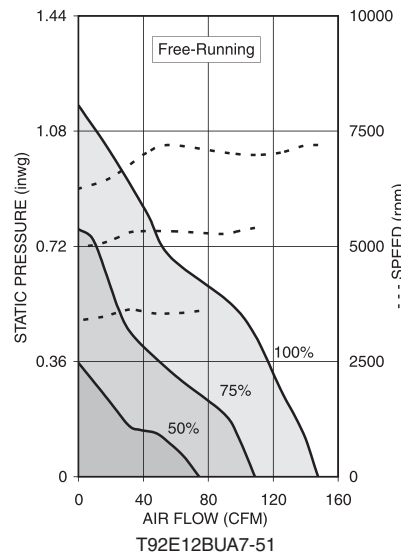
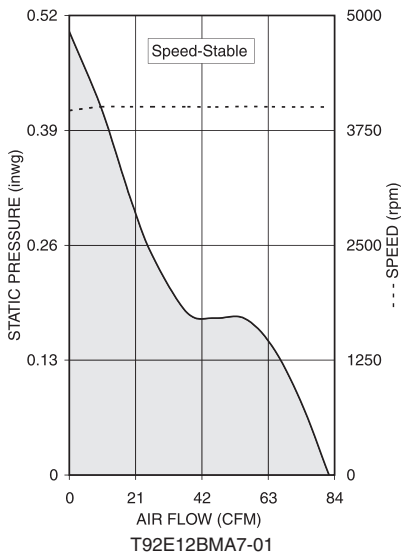
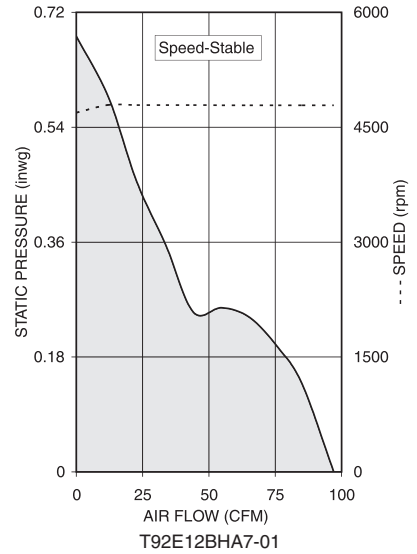
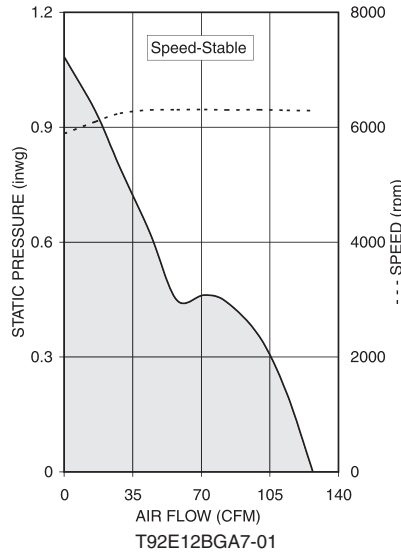
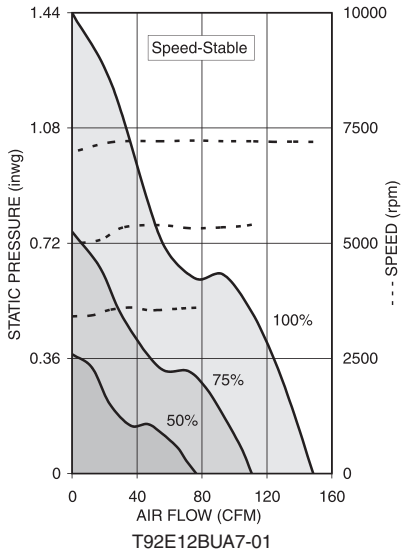

T92E Series



All for dreams